

# Assembly instructions

Model: Kingston CT

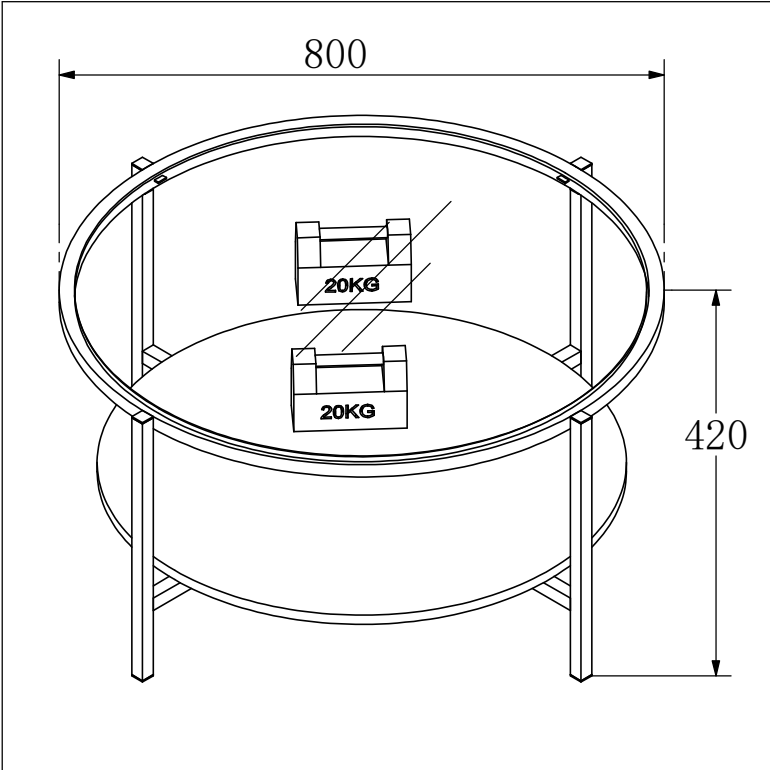

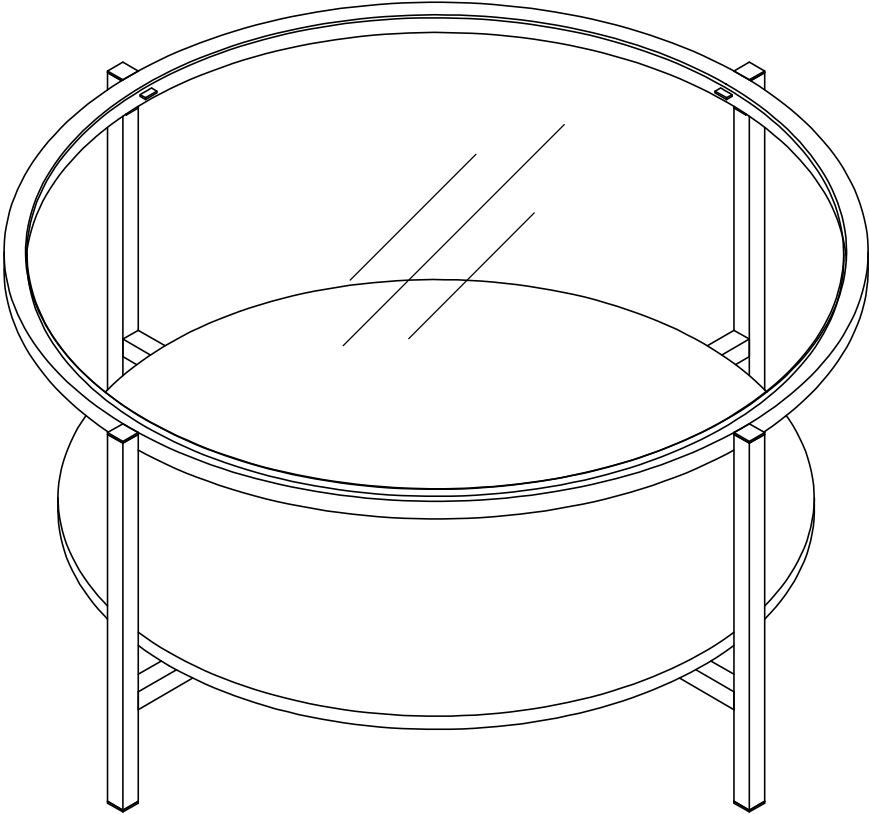

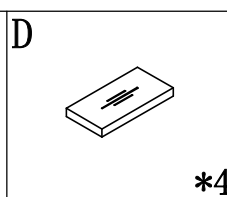
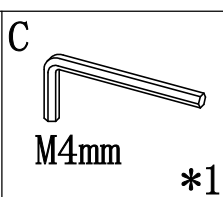
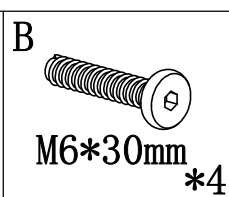
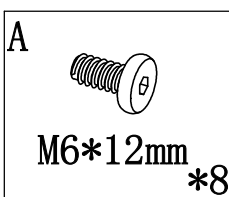
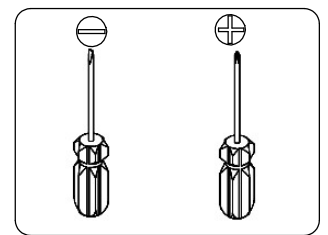
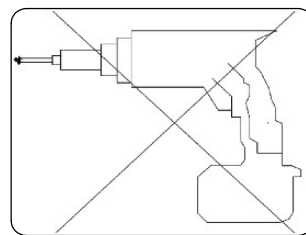
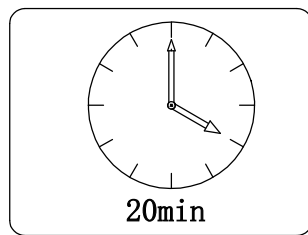
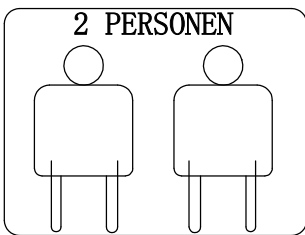
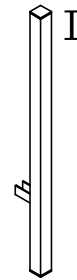
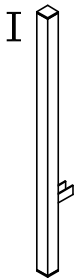
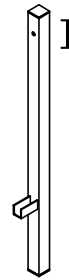
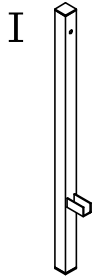
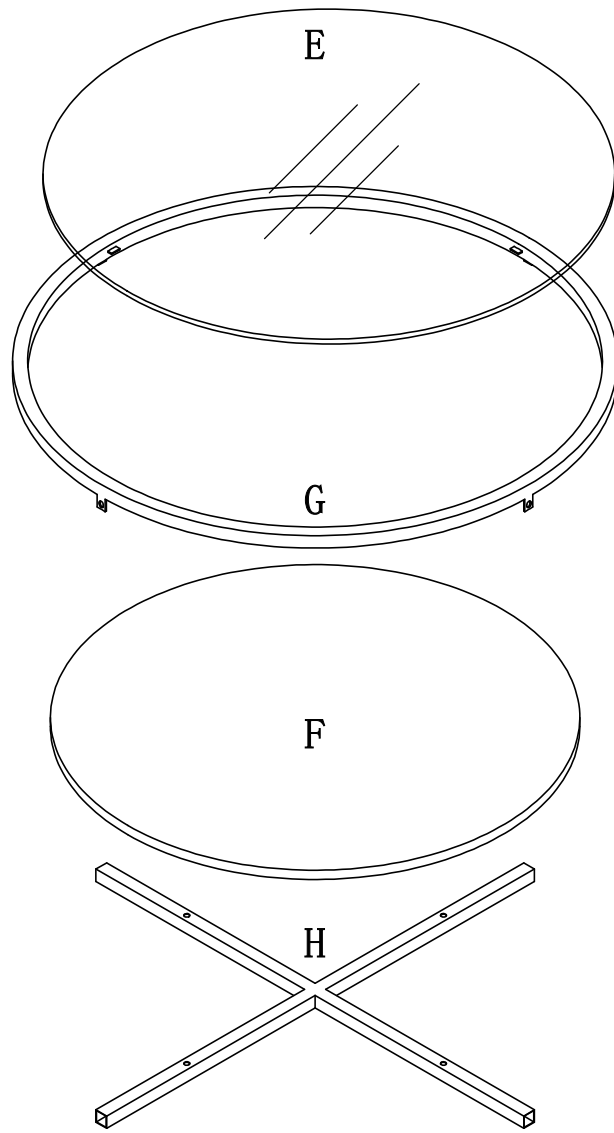

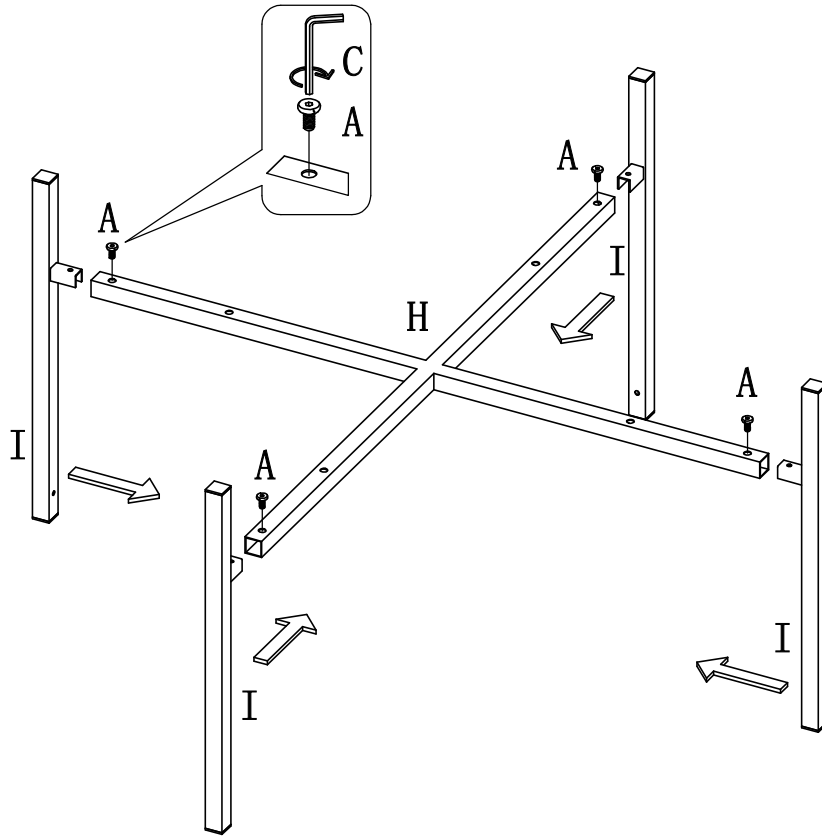
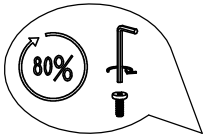
# Step:1

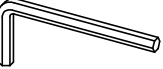

- A   
M6\*12mm  
\*4
- C   
M4mm  
\*1

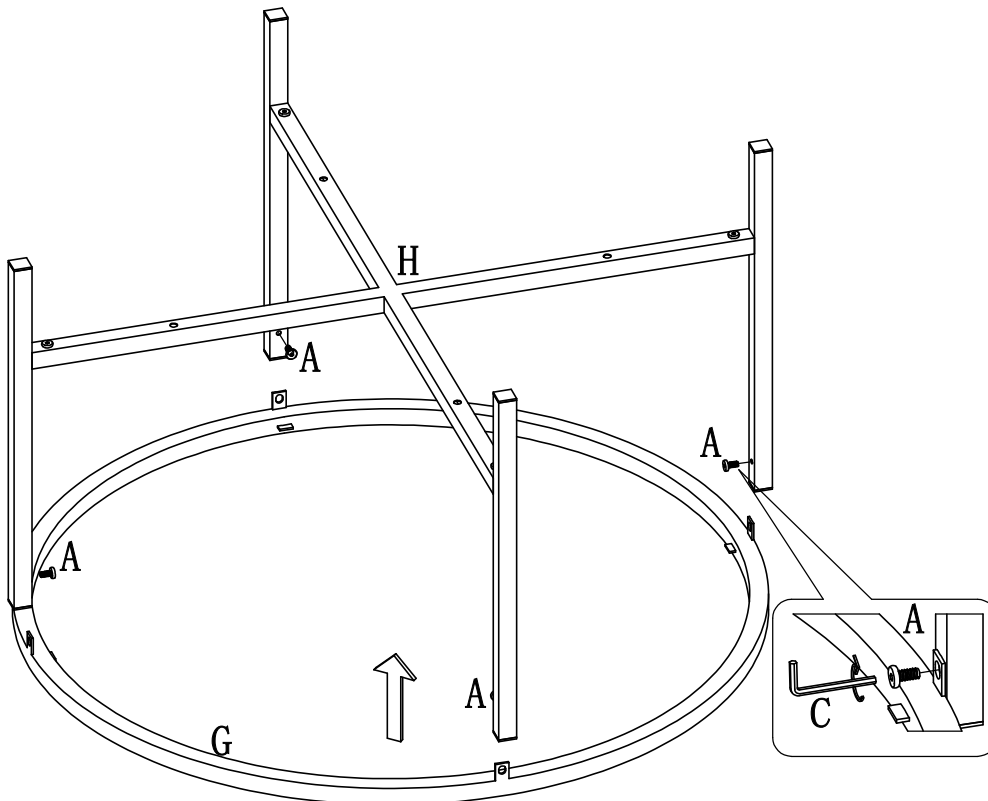
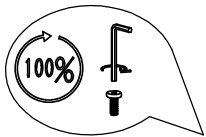
# Step:2

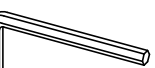

- A   
M6\*12mm  
\*4
- C   
M4mm  
\*1

# Step:3

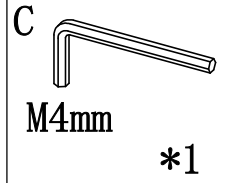
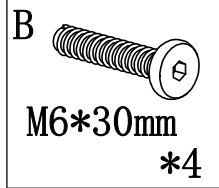
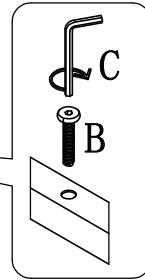
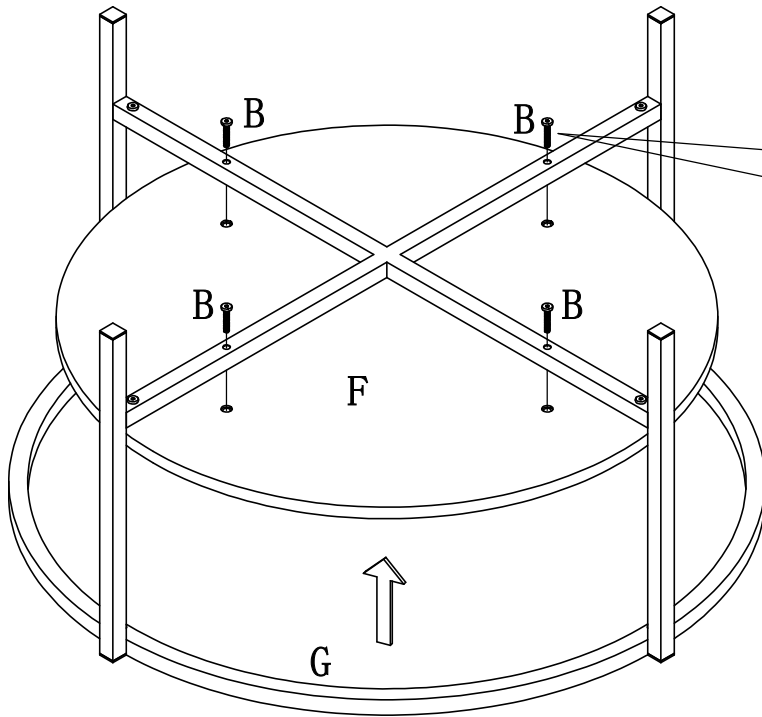
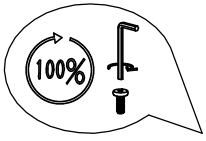

**Tighten all the screw completely**

# Step:4

